



Lightning and surge protection concept for data centres

White paper



Content

Lightning and surge protection
measures – an essential com-
ponent in the safety concept

Normative requirements

Risk assessment

Lightning protection system

Earthing system

Shielding and equipotential
bonding network

Lightning protection zone concept

Low-voltage main distribution
board

Sub-distribution board

Server rooms

Technical building equipment

Lightning and surge protection concept for data centres

White paper



Lightning and surge protection measures – an essential component in the safety concept

Data centres are cornerstones of our modern lifestyle and the basis of further digitalisation. They ensure the flow of information and provide data memory services for crucial processes of everyday life. Whether it is social networks, entertainment, public health, energy, telecommunications, traffic or state bodies – all of these things are reliant on the services of data centres. This development has intensified during the Covid-19 pandemic and the resulting global lockdown, which dramatically accelerated demand for online services. Rising in tandem with the growing importance of data centres is the pressure placed on their infrastructure to ensure an unrestricted flow of data. The dangers posed by the impact of lightning and surges represent significant yet often overlooked risk factors. This is where a lack of precautions can have wide-ranging consequences, such as fires, downtimes of important systems and even data loss.

An integrated lightning and surge protection concept is especially important, because a data centre is much more than just a building. It consists of a large number of interlinked electrical and electronic subsystems which are all designed to maintain the flow of information whereby they are online and always available. The server racks, with their respective memory systems, represent the heart of these centres. They are supported by additional infrastructure, such as the uninterruptible power supply (UPS), cooling or emergency power supply. Fire, power failure, problems with the network quality, overheating and

device deterioration are additional risk factors that need to be monitored by many support systems. All of these things, their functionality and especially their seamless interplay are critical for normal service operation and the continuous flow of data this entails. As online service providers, it is therefore indispensable for data centres to have comprehensive protection 24 hours a day, 7 days a week, 365 days a year (24 / 7 / 365). For this reason, a lot of know-how goes into the security, operation and safeguarding of data centres.

This is why lightning and surge protection measures are an essential component in this safety concept. It is important to factor these things in early on in the planning stage, because in this phase implementation is considerably easier. Retrofitting is often only achieved with difficulty, and mostly associated with a very high financial cost.

Normative requirements

EN 50600 is the first Europe-wide and transnational standard stipulating an integrated approach and comprehensive specifications for the planning, construction and operation of a data centre. Lightning protection measures are required in part 2-2 of this standard, "Power supply and distribution" of data centre equipment and infrastructure. Specifically, this part refers to the entire EN 62305 "Protection against lightning" series of standards.

However, in addition to EN 62305, there are other standards – also mentioned in EN 50600 – which must be followed to ac-

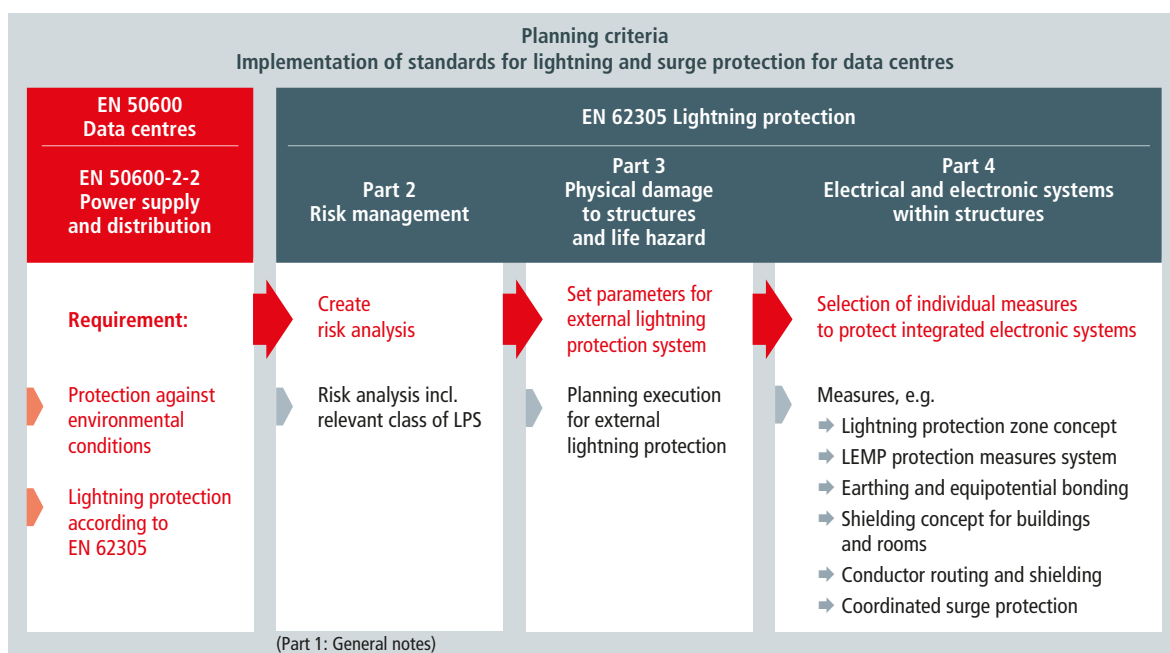

Figure 1 Flowchart for the planning of lightning and surge protection for data centres

Lightning and surge protection concept for data centres

White paper



count for all aspects of lightning and surge protection. These are, for example:

- ➔ EN 50174-2, Information technology – Cabling installation – Part 2: Installation planning and practices inside buildings
- ➔ EN 50174-3, Information technology – Cabling installation – Part 3: Installation planning and practices outside buildings
- ➔ IEC 60364-4-44:2007/A1:2015 – subsection 443: Protection against transient overvoltages of atmospheric origin or due to switching
- ➔ IEC 60364-5-53 – Low-voltage electrical installations – Part 534: Selection and erection of devices for protection against transient overvoltages
- ➔ DIN EN 61000 Part 4-9 - Electromagnetic compatibility (EMC) – Part 4-9: Testing and measurement techniques
- ➔ DIN EN 61000 Part 4-10, electromagnetic compatibility (EMC) – Teil 4-10: Testing and measurement techniques

The lightning protection standard **EN 62305** constitutes the basis for the standard-compliant design and implementation of lightning and surge protection concepts as well as shielding measures. It covers the following aspects:

- ➔ **EN 62305-1 General principles.** The section provides an introduction to the topic of lightning protection with general principles and definitions of terms
- ➔ **EN 62305-2: Risk management.** The risk assessment is the basis for the correct implementation of the protection measures described in Part 3
- ➔ **EN 62305-3: Physical damage to structures and life hazard.** This part deals with the practical implementation of an external lightning protection system that protects the building and the people located inside it.
- ➔ **EN 62305-4 Electrical and electronic systems within structures.** This part deals with the protection of electrical and electronic systems against the effects of lightning electromagnetic impulses (LEMP).

The flowchart depicted in **Figure 1** is tried and tested in practice for the planning and implementation of the relevant measures on the topic of lightning and surge protection:

The starting point is usually a risk analysis that defines the necessary detailed measures for lightning and surge protection. This delivers an individual assessment applicable to the specific building as per EN 62305-2. It should be coordinated between the planning engineers and building operator. For a data centre, this usually equates to a lightning protection system of maximum effectiveness, meaning class of LPS I. The protection measures resulting from the risk analysis are described in detail in parts 3 and 4 of the EN 62305 series of standards (international basic standards:

IEC 62305-3 and IEC 62305-4). When assessing whether lightning protection is necessary, check whether lightning protection is required by law or by the authorities and whether specific protection classes/protective measures have been defined.

Based on EN 62305 Part 3, the following implementation details are defined, such as:

- ➔ Effectiveness of the lightning protection system
- ➔ Mesh size of the lightning protection system
- ➔ Protective angle for air-termination rods
- ➔ Necessary parameters for calculating the separation distance
- ➔ Lightning equipotential bonding measures

These specifications primarily concern precautions that should reduce physical damage to structures and prevent harm to people. Such an analysis on its own will not suffice for the strict safety requirements of data centres. In order to prevent the failure of electrical and electronic systems, additional protection measures must be considered. To this end, incorporating EN 62305-4 is necessary. This describes individual measures for preserving sensitive, integrated systems against damage and failure.

Risk assessment

Foresighted risk management helps a planning engineer to evaluate risks more accurately. It provides the basis for decision-making in order to limit the present risks and provide transparency about which residual risks might sensibly be covered by insurance or which failure probability is acceptable to the operator.

The aim of the assessment is to quantify the risk to structures and their contents from direct and indirect lightning strikes. The risk analysis specified in EN 62305-2 ensures that a lightning protection concept which is comprehensible for everybody concerned can be created. This is technically and economically optimised so that the requisite protection is ensured with as little cost as possible. The procedure for this contains the following steps:

- ➔ **Assessment of the structure:** In the first step, there is an evaluation of the building based on its facilities, location and risk potential. The result of this assessment is a risk of damage (factor R_x) in the form of a numerical value, which is compared to a tolerable risk R_T . Wird dieser Wert überschritten, sind gezielt Maßnahmen zur Risikominimierung auszuwählen. **Figure 2** shows a simplified representation of the relationship between the cause of the damage, sources of damage and types of the damage. This allows for an initial overview of the risk potential.

If a specific protection class for a lightning protection system is specified in a law, ordinance, directive or the building

Lightning and surge protection concept for data centres

White paper

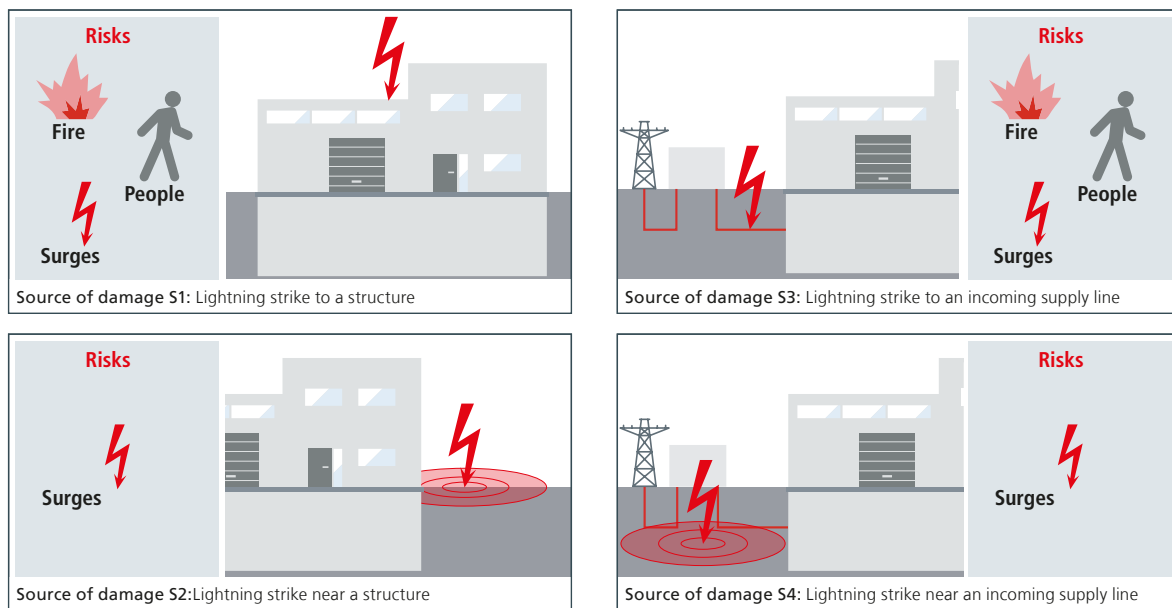

Figure 2 Simplified representation of the relationship between the source of the damage and the risk

permit, or if specific protective measures are listed, these must be implemented. In this case, a risk analysis in accordance with EN 62305-2 is not required.

➔ **Definition of protection measures:** Based on the determined risk, specific protection measures are defined in the next step. The basis for this is the determination of a Lightning Protection Level (LPL) for the structure. The classification into an LPL is used in the further planning process for the dimensioning and selection of protective measures, e.g. shielding and equipotential bonding measures. The protection class of the LPS (Lightning Protection System) is also determined by the LPL. The aim is to reduce the risk of damage to an acceptable level. Internal lightning protection activities (surge protection) based on the so-called lightning protection zone concept follow as a further protection component.

The risk analysis – especially for sensitive and challenging systems like data centres – is very extensive and correspondingly complex to implement. DEHN supports planning engineers, experts, lightning protection specialists and project managers in this regard with tools and services.

➔ For example, the DEHNsupport Toolbox software assists with the risk assessment and simplifies the calculation. Individual parameters can be modified easily using the software. The risk assessment is adjusted automatically without having to completely restart the calculation.

➔ Support is also provided by DEHN as a service in the area of risk analysis. The DEHNconcept team conducts an appropriate analysis for planning engineers and supplies the finished planning documents ready for use. To do this, the necessary input parameters must merely be defined together with the client beforehand.

As mentioned previously, the risk assessment is the basis – as per EN 62305-3 and DIN EN 62305-4 – for defining the first protection measures for both the internal and external lightning protection system in a subsequent step.

Lightning protection system

According to EN 62305-3, a complete external lightning protection system (LPS) consists of the following elements: Air-termination system, down conductor, earthing system, separation distance and lightning equipotential bonding.

The main task of the external lightning protection system is to intercept lightning strikes efficiently and safely, and to conduct the lightning current into the earthing system via the down-conductor system. When it comes to data centres with LPS class I, the challenge regularly faced is accommodating the required number of air-termination rods at the correct separation distance in combination with the planned shielding measures on the roof surface. The large number of technical installations on the roof surface often makes this a tough requirement to meet.

Lightning and surge protection concept for data centres

White paper

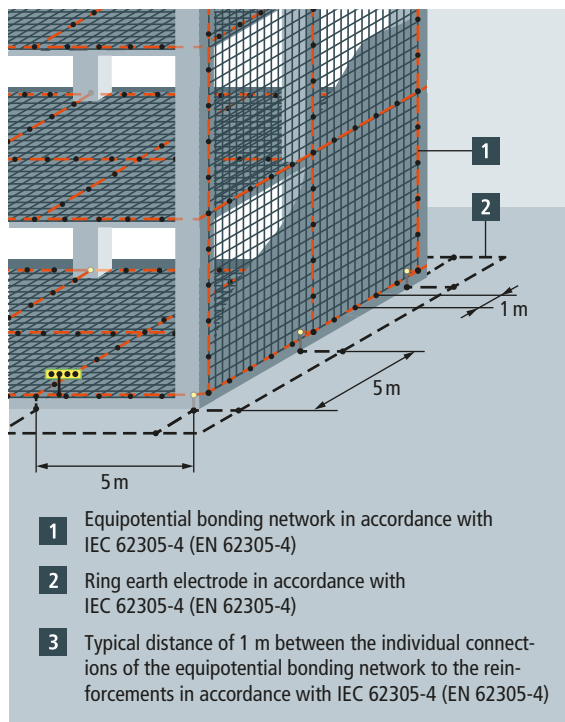

Figure 3 Example usage of the building structure for the formation of equipotential surfaces

For empty, flat roofs, a conventional lightning protection system consists of a combination of a meshed network with air-termination rods and is therefore usually a simple and elegant solution. However, this becomes difficult if there are already many superstructures on the roof. On data centres, there are, e.g., air-conditioning systems, such as cooling towers and chillers, or PV modules. These superstructures usually make the correct implementation and preservation of the required separation distances very tricky with a conventional lightning protection system. On top of that, they are exposed to lightning strikes and allow lightning currents to penetrate the data centre through the connected connecting cables. Furthermore, most data centres are built nowadays with the option to expand the installations or to modernise by adding new superstructures or repositioning existing ones in the future. In these cases, a conventional lightning protection system must be modified retroactively with great effort involved. Another important topic is adhering to the required separation distances. The separation distance is defined in IEC 62305-3 as the "distance between two conductive parts in which no dangerous sparks can emerge". Separation distances can be minimised through the sensible use of natural resources (e.g. the building fabric as a lightning protection system) through the formation of so-called equipotential surfaces.

This is an important subject for data centres in particular. Here, consistent use and implementation of the measure must be ensured to distribute the high impulse currents of up to 200 kA (waveform 10/350 μ s) quickly and safely to a large number of parallel paths. The actual length of the air-termination system required to calculate the separation distance can be reduced through the formation of such equipotential surfaces (Figure 3).

With data centres, it is important to use the natural building fabric as part of the lightning protection system through careful and foresighted planning.

For the correct formation of equipotential surfaces in connection with the equipotential bonding measures, mesh sizes of 5 m x 5 m are to be provided in the reinforcement. They must be connected to the available reinforcement every metre. The objective here is to connect as many metal components as possible, e.g. reinforcement bars / steel supports, to the potential level in order to avoid potential differences. In addition, all electrical and metal installations / equipment (e.g. air conditioning systems) must be connected to this equipotential bonding network. These measures reduce loop formations to the greatest possible extent and shift the reference area for calculating the separation distance to the top floor ceiling of the data centre. The down-conductor system and the connection to the earthing system are thus provided through the equipotential surface.

Another advantage of equipotential surfaces is the reduction in impedance of the resulting equipotential bonding network. The resulting electromagnetic field is thus reduced and internal electrical conductors and systems are burdened significantly less.

If, despite the installation of equipotential surfaces, the resulting reduced separation distance for example to internal electrical lines cannot be maintained, then these lines must be included in the lightning equipotential bonding via SPDs. Although these SPDs carry partial lightning currents, their energy content is very much reduced, so that type 2 or type 3 SPDs are usually sufficient here (Table 1).

Isolated lightning protection equipment – such as HVI (High-Voltage Insulation) Conductors – offers clear advantages, especially for the application environment mentioned above dense with roof-mounted structures. It quickly solves the "separation distance" problem, is space-saving and massively simplifies the installation of air-termination systems (Figure 4).

The concept of the HVI Conductor consists of a lightning-current-carrying conductor enclosed in an insulating material, so that the required separation distance to other conductive parts of the building, electrical conductors and pipes is maintained. The conductor consists of an inner copper conductor with thick-walled, high-voltage-resistant insulation and a semi-conductive, weather-proof special outer sheath that prevents flashovers along the surface of the conductor.

Lightning and surge protection concept for data centres

White paper



LPL	Recommendation type 2 arrester ⚡	Recommendation type 2 arrester ⚡
LPL I	Nominal discharge current: I_n 20 kA (8/20 μ s) / pole	Nominal discharge current: I_n 10 kA (8/20 μ s) / pole
LPL II	Nominal discharge current: I_n 15 kA (8/20 μ s) / pole	Nominal discharge current: I_n 10 kA (8/20 μ s) / pole
LPL III – IV	Nominal discharge current: I_n 10 kA (8/20 μ s) / pole	Nominal discharge current: I_n 10 kA (8/20 μ s) / pole

Table 1 Recommendation type 2 arrester



Figure 4 Application examples of HVI air-termination systems

An air-termination system using a HVI system prevents the risk of data centres dense with roof-mounted structures from being damaged by direct lightning strikes, or flashovers and the flowing of partial lightning currents from interrupting the power supply or signal cables. Uncontrolled impulse currents are thus prevented from getting inside the building via connecting cables.

An insulated lightning protection system should also be considered if partial lightning currents entering the structure could interfere with or destroy sensitive electrical or electronic equipment.

Earthing system

The earthing system of a data centre has a variety of tasks. For this reason, great care must be taken to ensure proper implementation, because making subsequent corrections that are technically on a par is barely possible and, if it is, involves considerable additional effort. The earthing is not only the contin-

uation of the air-termination system and the down-conductor system for distributing the lightning current into the ground, but is also the basis for low-impedance equipotential bonding, i.e. an equipotential surface which is as ideal as possible.

Remember that a common, global earthing system is preferred for the different electrical systems (the lightning protection, medium-voltage, low-voltage, telecommunications, shielding and equipotential bonding system). The earthing system that arises in this way is connected to the technical installations inside the data centre via fixed earthing terminals or equipotential bonding bars.

National standards – e.g. DIN 18014 in Germany – usually apply for the erection of earthing systems in buildings. In conjunction with lightning protection systems, however, the requirements are defined in EN 62305-3. In addition, EN 50310 must be observed here. This standard defines requirements for planning and installation of connections to establish equipotential bonding between different electrically conductive com-

Lightning and surge protection concept for data centres

White paper



ponents. It refers, in particular, to buildings and structures in which information technology and telecommunications equipment is installed.

When planning data centres, the planning principles described in EN 50600-1 must be observed. Regarding ways to prevent electromagnetic interference in data centres, reference is made to EN 50600-2-2, which in turn refers to EN 62305-4 concerning a LEMP protection concept. To this end, EN 62305-4 must be applied for the planning of data centres.

In the floor slab of the data centre, the foundation of the equipotential bonding network or the foundation earth electrode must be set up with a mesh of maximum 5 m x 5 m (Figure 5). The functional equipotential bonding conductor must be conductively connected to the existing reinforcement every metre in a manner capable of carrying lightning current and serves as the basis of the equipotential system reaching to the roof surface (Figure 6). The necessary mesh size of the function-

al equipotential bonding conductor in combination with the mesh size of the shielding measure, must be calculated depending on the LPL, the immunity of the systems to pulsed magnetic fields and the attenuation to be achieved. The physical arrangement of the equipment must also be taken into account. The basis for this is DIN EN 62305-4 as well as DIN EN 61000-4-9 and DIN EN 61000-4-10.

Data centres usually have an earth electrode embedded in waterproof concrete, which cannot be described as being in direct contact with earth. For this reason, a ring earth electrode with a mesh size of 5 m x 5 m (Fig. 7) is required beneath or outside of the foundation earth electrode. The ring earth electrode is laid directly in the ground and is thus subjected to a high corrosion load. Stainless steels with a proportion of molybdenum of > 2% e.g. V4A material no. 1.4571/1.4404 must be used for this. The ring earth electrode must be connected to the foundation earth electrode every 5 metres.

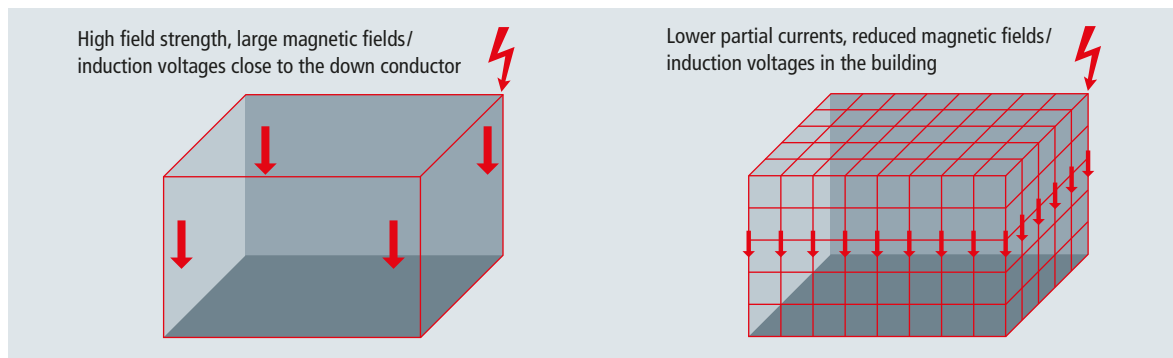

Figure 5 Operating principle of grid structures for lightning current distribution

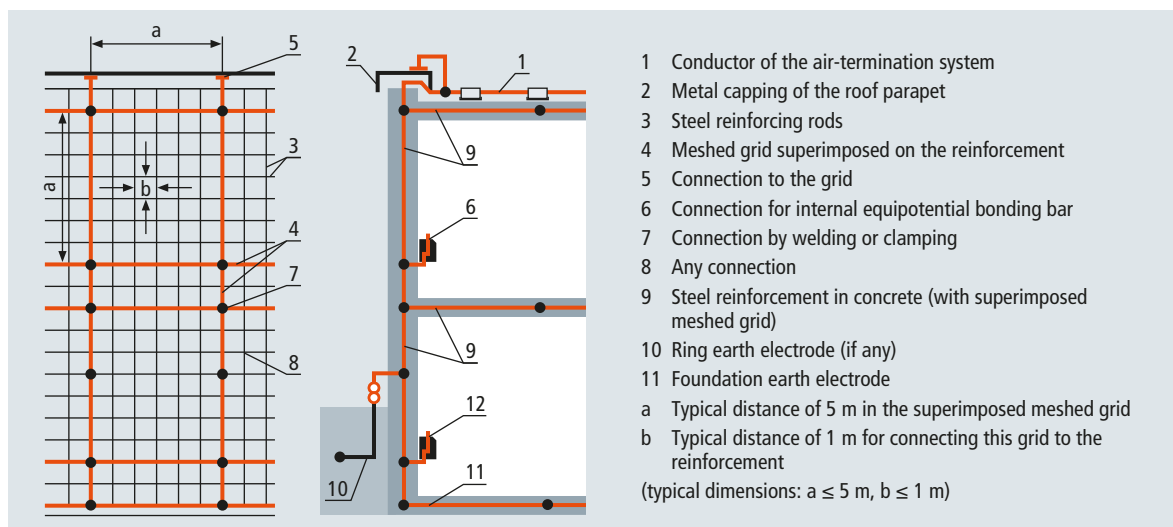

Figure 6 Example set-up of the equipotential bonding network in conjunction with the steel reinforcement of the building

Lightning and surge protection concept for data centres

White paper

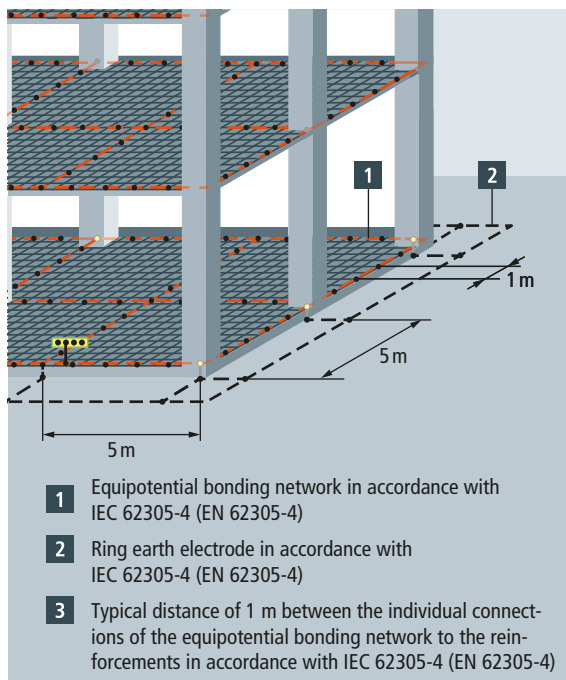

Figure 7 Set-up of a ring earth electrode underneath a building

Shielding and equipotential bonding network

Lightning, which delivers an enormous amount of energy in a very short space of time, generates a strong electromagnetic impulse, or lightning electromagnetic impulse (LEMP). For this reason, when protecting sensitive electronic systems, the danger posed by induced voltage impulses must be taken into account (Figure 5). LEMP can arise both due to a direct lightning strike into the building and also due to a lightning strike in the vicinity of the building.

In addition to the equipotential bonding of all conductive parts of a building (as already explained in the preceding sections), building or spatial shielding substantially improves protection against LEMP. Shielding measures can be easily integrated and designed into the building structure during the planning and construction of the data centre. Retroactive measures are often only associated with very high costs and low effectiveness.

In exceptional cases, a data centre will already be surrounded by an external, conductive metal shell, for example, metal curtain walling, which is connected to the equipotential bonding network. However, in most cases the equipotential bonding network manifests as a conductive network (e.g. by incorporating metal reinforcement) in the building walls or a particular section of the building. Server rooms inside the data centre are an example of such sections of the building. Depending on the

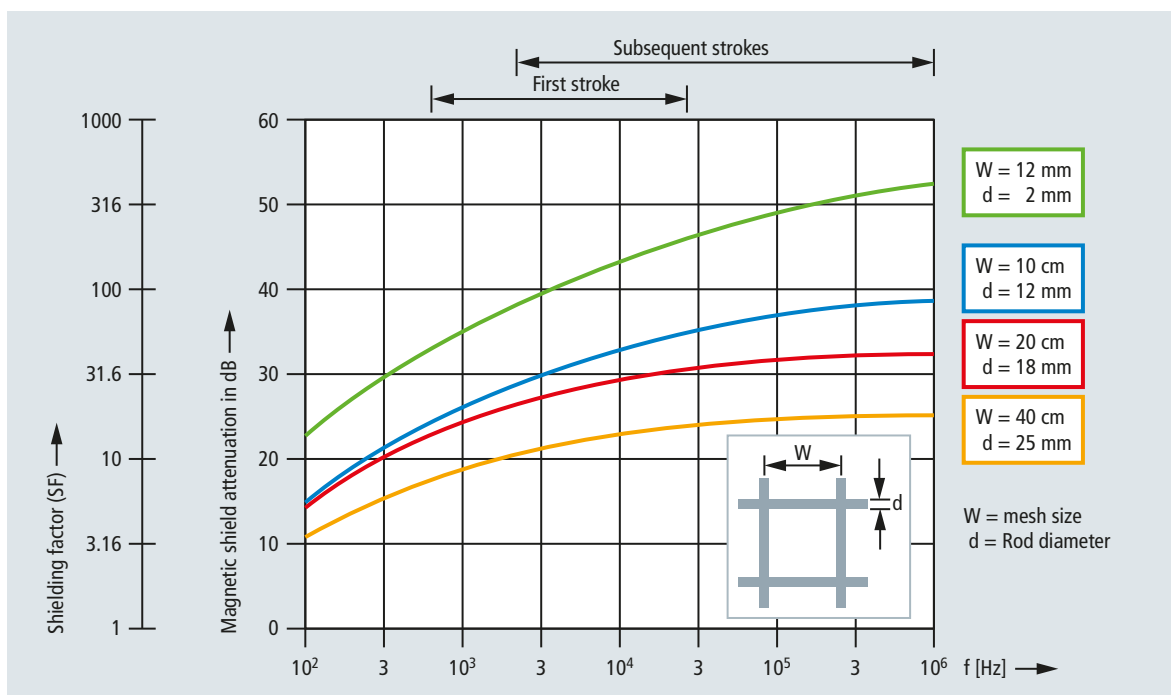

Figure 8 Shielding effectiveness of the reinforcing steel used as per VG 96907-2-2011-01 (Protection Against Nuclear Electromagnetic Pulse (NEMP) and Lightning Strikes).

Lightning and surge protection concept for data centres

White paper



data security and the immunity of the electronic devices in the room, these can be provided with additional spatial shielding. The chosen mesh size and the additional use of reinforcement play a key role in the effectiveness of this shielding measure (Figure 8).

In order to achieve sufficient attenuation of the magnetic field, a detailed analysis must be carried out for data centres in accordance with DIN EN 62304-4. The sources of damage S1 (direct lightning strike) and S2 (lightning strike next to the structure) are to be considered here. In addition to the lightning current parameters of the first positive short stroke (25 kHz), subsequent short strokes (1 MHz) must also be taken into account when designing the shielding measures. In order to be able to classify the effectiveness of the shielding measures, the calculated results must be compared with the maximum permissible reference values according to DIN EN 61000-4-9 and DIN EN 61000-4-10. These are the maximum field strengths of a pulsed magnetic field. The decisive factor for the selection of the reference value is the test level to be defined. As a rule, test level 3, which represents the electromagnetic environment in offices and business and commercial areas, is applied. Windows and doors must also be integrated into the shielding measures. It is important to ensure that these also have sufficient attenuation characteristics (e.g. windows with metal mesh). **Prior to the construction work, computer simulations can provide a detailed course of the electromagnetic field in case of lightning interference. (Figure 9)**

The aim is to be able to form an almost closed "Faraday cage" around a defined area for sensitive electronics. In this area, the electromagnetic field caused by lightning current pulses is to be reduced to such an extent that the disturbance variable is attenuated by the shielding measure calculated according to EN 62305-4 so that the immunity of the equipment is not exceeded. The magnetic field must therefore be reduced to such an extent that the immunity of the equipment is higher than the actual or calculated load at the installation location. Special simulation software solutions are available for estimating the magnetic field strength, taking shielding measures into account.

With a mere grid structure of the equipotential bonding network of 5 m x 5 m, it can be assumed that the electromagnetic interference of the lightning within the structure is reduced by a factor of 2 (6 dB). Openings such as those needed for cable bushings should be kept to a minimum. All lines that are laid from the outside into a shielded room can carry surges into the protected environment and eliminate the intended protection goal. It is therefore important to include them in the equipotential bonding network at the corresponding zone boundaries according to the lightning protection zone concept by means of surge arresters. Optimised cable routing also minimises induction loops and thus reduces the occurrence of

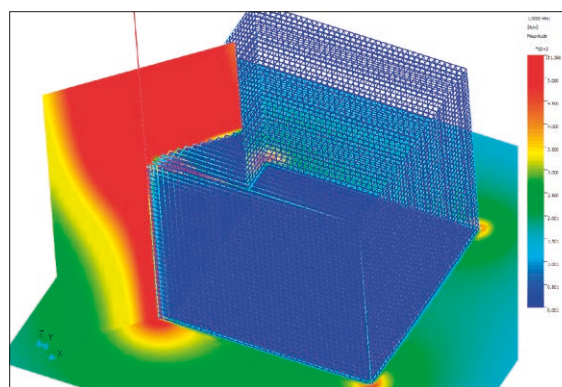

Figure 9 Computer simulation to simulate the electromagnetic field in the event of a direct lightning strike (Source: Hannig)

surges. A further method of preventing surges from entering the protected area via cables is to shield cables in accordance with EN 62305-4 and include them in the existing equipotential bonding network.

Equipotential bonding network

The main function of the equipotential bonding network is to prevent hazardous potential differences between all devices/ installations inside the building and to reduce the magnetic field of the lightning strike. The low-impedance equipotential bonding network required is achieved by multiple interconnection of all metal components inside the structure. This results in a three-dimensional, intermeshed equipotential bonding network (Figure 9). Typical components of this network are:

- ➔ All metal installations (e.g. pipes)
- ➔ Reinforcement in the concrete (in floors, ceilings and walls)
- ➔ Grating (e.g. for intermediate floors)
- ➔ Cable ducts
- ➔ Ventilation ducts
- ➔ Lift rails
- ➔ Supply lines (gas, water, etc.)
- ➔ Windows and doors

Enclosures and racks of electronic devices and systems should be integrated in the equipotential bonding network by means of short connections (where possible not in round wire, according to DIN VDE 0100-444). To do this, suitable connection elements, such as fixed earthing terminals and equipotential bonding bars, should be provided for in the plan at prominent points in the data centre.

Lightning protection zone concept

In order to meet the strict requirements of availability of sensitive electronic systems in data centres, the lightning protec-

Lightning and surge protection concept for data centres

White paper

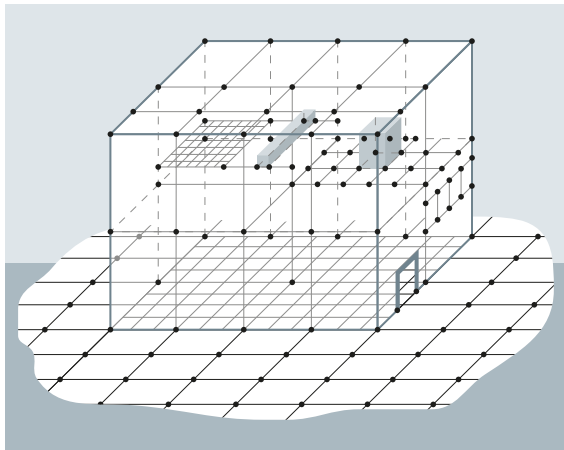

Figure 10 Three-dimensional, intermeshed equipotential bonding network

tion zone concept as laid out in EN 62305-4 is employed. According to this principle, the structure to be protected must be divided into inner lightning protection zones (LPZ) according to the risk level posed by the LEMP (Figure 10). With this flexible concept, suitable LPZs can be defined according to the sensitivity of the electronic devices/systems. Depending on the threat, inner and outer lightning protection zones can be defined as per EN 62305-4.

➔ Outer zones:

- ➔ **LPZ 0:** Zone where the threat is due to the unattenuated lightning electromagnetic field and where the internal systems may be subjected to the full or partial lightning current. LPZ 0 is subdivided into:
 - ➔ **LPZ 0_A:** Zone where the threat is due to direct lightning strikes and the full lightning electromagnetic field. The internal systems may be subjected to the full lightning current.
 - ➔ **LPZ 0_B:** Zone protected against direct lightning strikes but where the threat is due to the full lightning electromagnetic field. The internal systems may be subjected to partial lightning currents.

➔ Inner zones (protected against direct lightning strikes):

- ➔ **LPZ 1:** Zone where the impulse currents are limited by current distribution and isolating interfaces and/or by SPDs at the zone boundaries. The lightning electromagnetic field of the flash may be attenuated by spatial shielding.
- ➔ **LPZ 2...n:** Zone in which impulse currents can be further limited by current distribution and isolating interfaces and/or by additional SPDs at the zone boundaries.

Additional spatial shielding may be used to further attenuate the lightning electromagnetic field.

The requirements for the inner zones in the data centre must be defined according to the dielectric strength of the electronic systems to be protected. Equipotential bonding must be established at the boundary of each inner zone for all incoming metal parts and supply lines (in the case of more than one zone). This is done either directly or through surge arresters suitable for the respective lightning protection zone. The zone boundary is formed by the shielding measures. The correct implementation of the lightning protection zone concept is one of the most important aspects for safe and uninterrupted operation in data centres.

The number of internal lightning protection zones should be determined depending on the EMC protection concept. Depending on the type and structure, this can be done via one lightning protection zone, but also through several zones. The protection parameters to be achieved form the basis here.

Equipotential bonding at the zone boundaries

Equipotential bonding for all metal systems / structures must be established at the respective boundaries of the EMC lightning protection zones. The same applies to all power and IT cables. At the zone boundary $0_A/0_B-1$, meaning in the low-voltage main distribution board, they must be connected with lightning-current-carrying SPDs, so-called type-1 arresters, or combined lightning current and surge arresters. The strictest requirements are placed on these arresters in terms of their discharge capacity. They must be capable of repeatedly carrying lightning currents with a 10/350 μ s waveform without destruction. They must be used as close as possible to the building entrance and thus prevent destructive partial lightning currents from reaching electrical installations. LPS class I generally applies to data centres. For power cables, discharge capacities according to Table 2 and for IT cables according to Table 3 must be taken into account.

At the boundary of lightning protection zone 0_B to 1 and higher, or from lightning protection zone 1 to 2 and higher, type-2 SPDs are used to protect against surges. Their discharge capacity is within a range of a few 10 kA (8/20 μ s).

The last link in the lightning and surge protection system for power supply systems is the protection of terminal devices (transition from LPZ 2 to LPZ 3 and higher). The main function of a type-3 surge protective device installed at this point is to protect against overvoltages arising between the conductors of an electrical system. This applies in particular to switching overvoltages.

What is important here is that the SPDs used are coordinated together as per EN 62305-4 (Figure 12) and are installed at the correct points as per the lightning protection zone concept. (See also <http://www.vde.com/spd-koordination>)

Lightning and surge protection concept for data centres

White paper

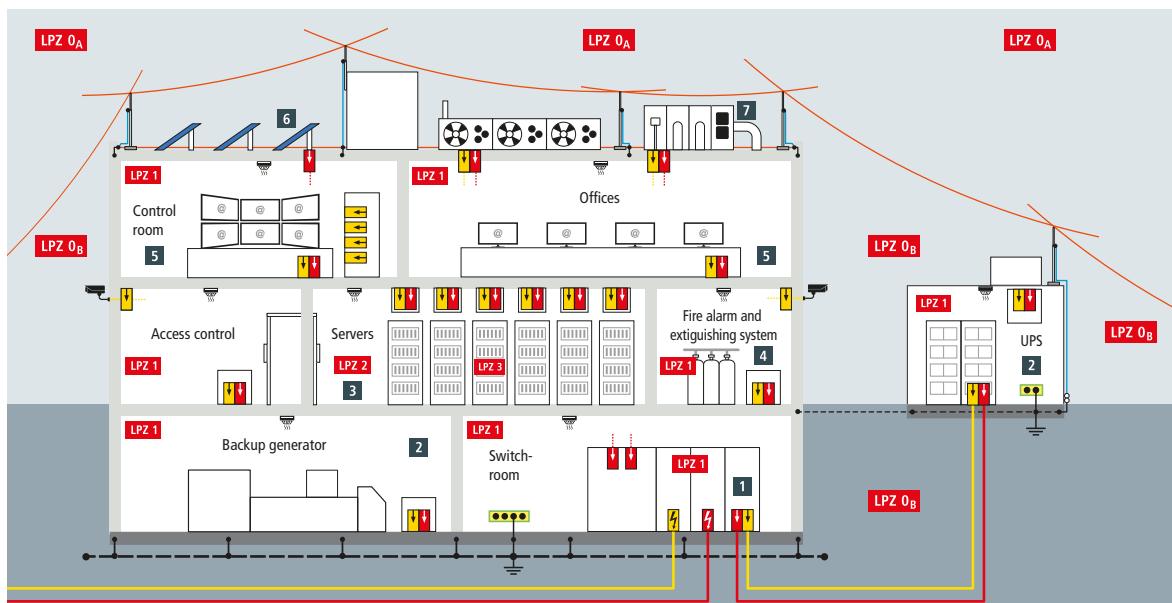

No.	Protection for...	Surge protective device	Part no.
1	Low-voltage switchgear	DEHNvenCI DVCI 255 FM	961 205
		Alternative: DEHNventil DV M2 TNS 255 FM	954 405
		BLITZDUCTORconnect BCO ML2 BD 24	927 244
		DEHNrecord SD DRC SD 2 1	910 921
2	Emergency power supply	DEHNguard ACI DG M TNS ACI 275 FM	952 440
		BLITZDUCTORconnect BCO ML2 BD 24	927 244
3	Server room	DEHNguard ACI DG M TNS ACI 275 FM	952 440
		BLITZDUCTORconnect BCO ML2 BD HF 5	927 271
4	Fire alarm system	BLITZDUCTORconnect BCO ML2 BE 24	927 224
		DEHNrail DR M 2P 255	953 205
5	Security centre, offices, IP cameras	DEHNrail DR M 2P 255	953 205
		DEHNpatch DPA CL8 EA 4PPOE	929 161
		DEHNpatch Outdoor DPA CLE IP66	929 221
		BLITZDUCTORconnect BCO ML2 BD HF 5	927 271
6	PV system	DEHNCube DCU YPV SCI 1000 2M	900 920
7	Roof-mounted structures (e.g. heating, air conditioning, ventilation)	DEHNguard ACI DG M TNS ACI 275 FM	952 440
		BLITZDUCTORconnect BCO ML2 BE 24	927 224

Figure 11 Example illustration of lightning protection zones for data centres and the lightning current and surge arresters installed there

Low-voltage main distribution board

The data centre's most important supply cables run together in the low-voltage switchgear installation. Fed by medium-voltage transformers, backup generators and the UPS system, enormous amounts of power are present here. For

safer operation lightning equipotential bonding must be established. In addition, conducted interference from downstream sub-distribution boards due to indirect lightning strikes must be taken into account. In these cases, lightning current arresters must be selected that are capable of dis-

Lightning and surge protection concept for data centres

White paper



Impulse current carrying capability I_{imp} in kA per pole for three-phase power supply systems		
Arrester connection	4 + 0	3 + 1
L-PE	25 kA	-
L-N	-	25 kA
N-PE	25 kA	100 kA

Lightning protection level I

Table 2 Discharge capacities for power cables (source: VDS2833)

charging massive lightning currents (as per LPS class I: 100 kA (10/350 μ s)) without destruction, but also of safely managing short-circuit currents that arise. Furthermore, the required protection level U_p should be less than or equal to the maximum rated impulse withstand voltage of the most sensitive equipment in the low-voltage switchgear installation. Use of a spark-gap-based combined arrester is best suited here, like the DEHNvenCI with integrated backup fuse (Figure 13). In addition to the significant savings in terms of space and installation work, the maximum cable length of 0.5 m required by IEC 60364-5-53 can easily be accommodated here too. The spark gap technology employed enables an energy-coordinated protection effect type 1 + type 2 + type 3, thus also safeguarding the most sensitive terminal equipment, such as bus controllers, sensors and electronic measuring equipment. If multiple transformers are to be separately switchable via coupling circuit breakers, they must be connected to the same surge arresters.

For large low-voltage switchgear installations, additional type-2 surge arresters should also be used at the outputs to the

Impulse current carrying capability I_{imp} in kA per pole for information technology systems	
Number of wires	
<3 pairs	2.5 kA
≥ 3 pairs	1 kA
≥ 10 pairs	500 A

Lightning protection level I

Table 3 Discharge capacities for IT cables (source: VDS2833)

connected sub-distribution boards. This way, induced disturbance variables from the outgoing lines are safely restricted. In addition, signal and data lines should also be connected to appropriate SPDs.

Sub-distribution board

A multitude of different systems require power supply further down the path in the data centre. Whether it is alarm systems, servers, sprinklers or air-conditioning systems – in no other type of building will you find more complex systems. Due to the cable lengths of more than 10 m common in this area, the effects of induction and propagation can arise here (Figure 14).

Induced surges in conductor loops are largely determined by the steepness of the lightning current rise $\Delta i/\Delta t$. These voltages are induced in all open or closed conductor loops located in the vicinity of conductors carrying lightning current. A calculation example for this is shown in Figure 15.

In order to eliminate these effects, or to limit them as much as possible, further down the path in the assigned sub-dis-

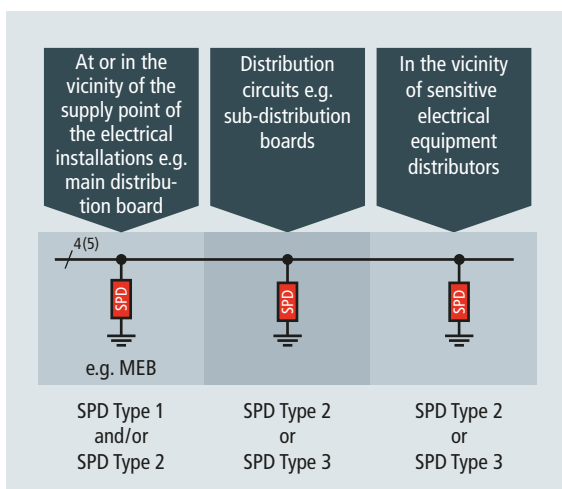

Figure 12 Coordinated use of surge arresters



Figure 13 Infeed protection in a building's main distribution board with DEHNvenCI

Lightning and surge protection concept for data centres

White paper



tribution boards, additional type-2 surge arresters should be used. In data centres in particular, the DEHNguard surge arresters with ACI (Advanced Circuit Interruption) technology can demonstrate their strengths to the full. The integrated switch-spark gap combination renders a device's previously necessary backup fuse superfluous. Upstream overcurrent protective devices which would otherwise be necessary can be done away with, enabling a simpler configuration, quick installation and the reliable operation of the surge protective devices.

Server rooms

Server rooms – or in the case of a larger data centre – a server hall usually comprise many rows of server cabinets. Power is supplied to the racks via floor boxes: either via cables, which are routed under the "raised floor", or via a special conductor rail (**Bild 16**).

The server room in a data centre can, depending on the shielding concept, be protected by an additional meshed network, meaning the spatial shielding. This makes it one of the most important locations inside the building. The entire room is therefore considered a lightning protection zone 2. In addition, the metal housing of a server can be specified as an additional lightning protection / shielding zone (e.g. LPZ 3). However, it must be taken into account that the complete cabinet, including the doors and their seals, has demonstrable, verifiable attenuation characteristics and is integrated separately into the equipotential bonding with at least a 6 mm² Cu earth conductor. Surge protection at the server room level differs based on the size of the server room. In the case of an unshielded server room, type-2 surge protection in the floor boxes is sufficient. In

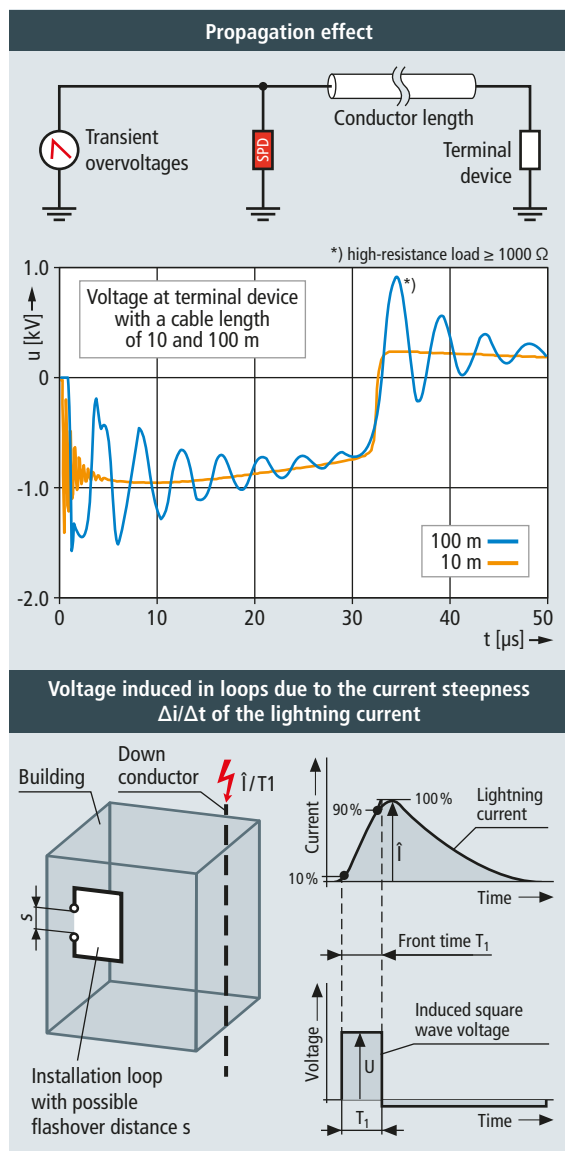

Figure 14 Propagation and induction effect across the cable length

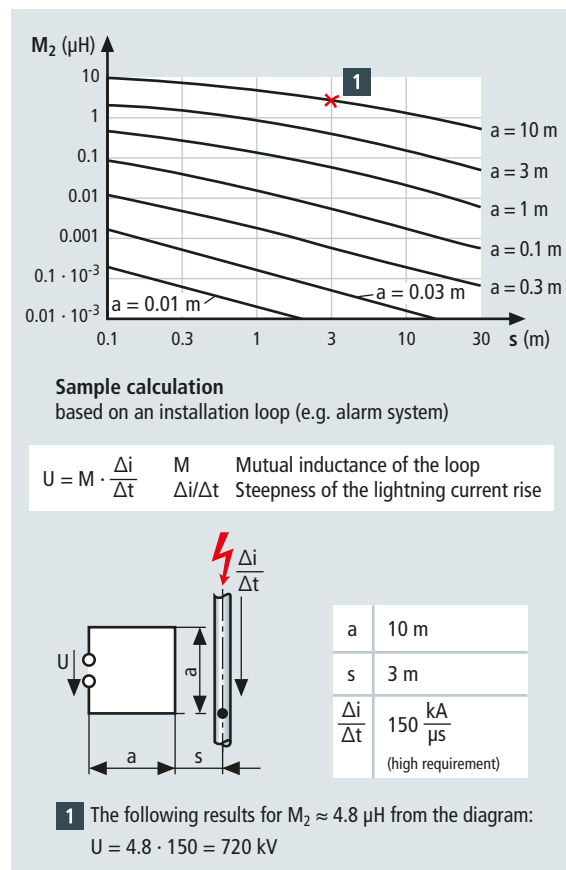

Figure 15 Sample calculation for induced voltages in squared loops

Lightning and surge protection concept for data centres

White paper

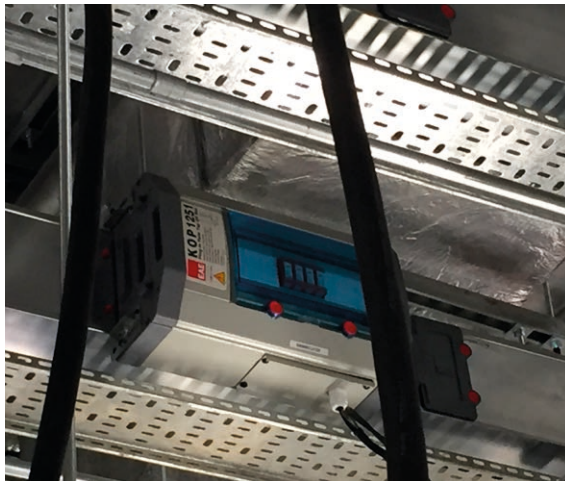

Figure 16 Power supply in the server room



Figure 17 Example use of the BLITZDUCTORconnect in the technical building equipment

larger server rooms, however, additional type-3 surge protection should be installed – either in the outputs on the busbar or in the rack power supply itself.

Technical building equipment

The term "technical building equipment" encompasses such things as heating, ventilation, air-conditioning, fire protection, sanitation and electrical equipment. In order to best control their functioning, interconnected monitoring, control and regulation components are required, the data of which is processed at many points in the building. If central installations fail due to damage from lightning and surges, then the data centre is also endangered here too.

The most important systems that need to be protected inside the building are the cooling system and the server itself. There are different strategies for securing a constant supply of power to these important loads, and the power supply is mostly backed up by an additional UPS system. However, as previously mentioned, due to the different locations and the large distances involved, all sub-distribution boards distributing to these loads must be protected against surges. The existing IT interfaces must also be secured against failure.

Due to the high degree of interconnection of all actuators, sensors, loads and controls, signals are processed at a wide variety of points in the building: whether that be in the building services management system, at information hubs or in the fire alarm control panel for connecting directly to the fire brigade (fire brigade peripherals). In the event of a failure due to surges, these components that are vital to the existence of the data centre will malfunction. This means the components of the ventilation and air-conditioning systems are no longer activated, and so fans, ventilation flaps or electrically powered

windows will go into an undefined state or remain in the last state before the event.

Protective devices of the BLITZDUCTORconnect range fulfil all of these requirements. Due to their high lightning current discharge capacity combined with a low voltage protection level, the downstream systems are reliably protected (**Figure 17**).

Technical building equipment data is frequently transmitted via Ethernet networks. As the systems are located inside and outside the building, indoor and also outdoor versions are required for this for the secure protection of industrial Ethernet, PoE (Power over Ethernet) and similar applications in structured cabling.

Another key function in the technical security of buildings is video surveillance. In addition to the proven CCTV systems, modern devices such as IP cameras offer better quality and energy efficiency. The high availability of these video surveillance systems must therefore be secured at all times. Furthermore, the quick and secure transmission of data and information inside the data centre is also important. With various connection options and the use of up to 250 MHz, the DEHNpatch range offers the right solution for diverse applications (**Figure 18**).

Conclusion

Digital technology is increasingly penetrating all areas of our work and lives, which means great dependence on secure and available communication and information technology. The Internet of things (IoT), autonomous driving, increasing mobile working and cloud computing are not possible without high-availability data centres. Powerful and extensive lightning and surge protection therefore forms an essential component of an integrated protection concept. This must be factored into planning early on, not only because this makes

Lightning and surge protection concept for data centres

White paper



Figure 18 Video surveillance protection with DEHNpatch

implementation considerably easier, but because it also means much less cost and effort compared to adding it in later phases of construction and operation.

Protection measures against the effects of lightning and surges are based on considerations including the results of a risk analysis, normative specifications such as EN 50600, Part 2-2, or the lightning protection standard EN 62305, as well as accounting for lightning protection zones and the specific agreement of the need for protection between planning engineers and the principal.

Sensitive and critical systems require robust safety precautions. For this reason, and for data centres in particular, the further requirements outlined in EN 62305-4 must be taken into consideration – with additional specifications regarding earthing measures, shielding or the protection of induced voltage impulses (e.g. LEMP).

Planning and implementing an integrated lightning and surge protection system professionally is a complicated task. As experts for lightning and surge protection, DEHN provides competent assistance, providing not only protection solutions, but also wide-ranging advice and other services.

DEHN – your one-stop shop for safety from the experts in lightning and surge protection.

DEHNrecord

DRC SD 2 1 (910 921)

- Measurement as per EN 61000-4-30:2015, class A
- Measurement of load and neutral conductor currents
- Device access via Ethernet interface



Figure without obligation

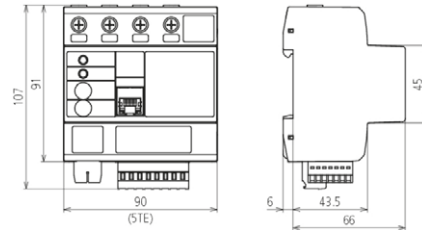

Dimension drawing DRC SD 2 1

Multifunctional measurement and analysis device for monitoring voltage quality

Type	DRC SD 2 1
Part No.	910 921
PQ measuring method as per EN 61000-4-30:2015	Class A
Power supply (U_B)	24 V _{DC}
Nominal input voltage range	24 V _{DC} SELV (max. 3 W)
Input voltage range	18–30 V _{DC}
Buffering the supply voltage during a power failure	Uninterruptible supply
Overvoltage category (standalone)	EN 61010 overvoltage category III
Overvoltage category (with surge protection)	Overvoltage category IV
Measurement category	EN 61010 measurement category III
Load current measuring range	up to 1 kA
Operating temperature range limits (storage and transport)	-40°C to +70°C
Operating temperature range limits (operation indoors)	-25°C to +55°C
Relative humidity (storage and transport)	5–95%
Relative humidity (operation indoors)	5–95%
Cross-sectional area L1 / L2 / L3 / N	1.5–6 mm ²
I / O connection	1x auxiliary voltage +12 V, 3x inputs up to max. 30 V _{DC} , 2x outputs (potential-free contact) up to max. 30 V, 500 mA
CM connection	4x inputs for current sensors
Plug cross-sectional area	0.25–1.5 mm ²
Capacity	5 module(s), DIN 43880
LED indicator 1	Device status
LED indicator 2	Message status
Degree of protection	IP 20
Communication	Ethernet, Modbus TCP, Cloud
Installation on	35 mm DIN rails acc. to EN 60715
Weight	380 g
Customs tariff number (Comb. Nomenclature EU)	90303200
GTIN	4013364460270
PU	1 pc(s)

DEHNvenCI

DVCI 1 255 FM (961 205)

- Spark-gap-based combined lightning current and surge arrester with integrated backup fuse capable of carrying lightning currents
- Maximum system availability due to RADAX Flow follow current limitation
- Capable of protecting terminal equipment



Figure without obligation

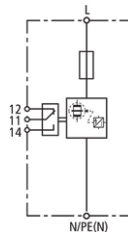

Basic circuit diagram DVCI 1 255 FM

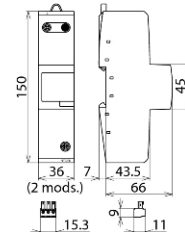

Dimension drawing DVCI 1 255 FM

Combined lightning current and surge arrester with integrated lightning current carrying backup fuse.

Type	DVCI 1 255 FM
Part No.	961 205
SPD according to EN 61643-11 / IEC 61643-11	type 1 + type 2 / class I + class II
Energy coordination with terminal equipment	type 1 + type 2
Energy coordination with terminal equipment (≤ 10 m)	type 1 + type 2 + type 3
Nominal voltage (a.c.) (U_N)	230 V (50 / 60 Hz)
Maximum continuous operating voltage (a.c.) (U_C)	255 V (50 / 60 Hz)
Lightning impulse current (10/350 μ s) (I_{imp})	25 kA
Specific energy (W/R)	156.25 kJ/ohms
Nominal discharge current (8/20 μ s) (I_n)	25 kA
Voltage protection level (U_p)	≤ 1.5 kV
Follow current extinguishing capability (a.c.) (I_f)	50 kA _{rms}
Follow current limitation / Selectivity	no tripping of a 20 A gG fuse up to 50 kA _{rms} (prosp.)
Response time (t_A)	≤ 100 ns
Max. mains-side overcurrent protection	not required
Rated breaking capacity of the internal backup protection	100 kA
Temporary overvoltage (TOV) (U_T) – Characteristic	440 V / 120 min. – withstand
Operating temperature range (T_U)	-40 °C ... +80 °C
Operating state / fault indication	green / red
Number of ports	1
Cross-sectional area (L, N/PE(N)) (min.)	10 mm ² solid / flexible
Cross-sectional area (L, N/PE(N)) (max.)	50 mm ² stranded / 35 mm ² flexible
For mounting on	35 mm DIN rails acc. to EN 60715
Enclosure material	thermoplastic, red, UL 94 V-0
Place of installation	indoor installation
Degree of protection	IP 20
Capacity	2 module(s), DIN 43880
Approvals	KEMA
Type of remote signalling contact	changeover contact
Switching capacity (a.c.)	250 V / 0.5 A
Switching capacity (d.c.)	250 V / 0.1 A; 125 V / 0.2 A; 75 V / 0.5 A
Cross-sectional area for remote signalling terminals	max. 1.5 mm ² solid / flexible
Extended technical data:	For use in switchgear installations with prospective short-circuit currents of more than 50 kA _{rms} (tested by the German VDE)
– Max. prospective short-circuit current	100 kA _{rms} (220 kA _{peak})
– Limitation / Extinction of mains follow currents	up to 100 kA _{rms} (220 kA _{peak})
Weight	435 g
Customs tariff number (Comb. Nomenclature EU)	85363090
GTIN	4013364145115
PU	1 pc(s)

DEHNventil

DV M2 TNS 255 FM (954 405)

- Prewired spark-gap-based type 1, type 2 and type 3 combined arrester consisting of a base part and plug-in protection modules
- Compact unit meets maximum safety requirements thanks to Rapid Arc Control (RAC)
- Capable of protecting terminal equipment



Figure without obligation

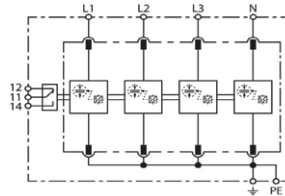

Basic circuit diagram DV M2 TNS 255 FM

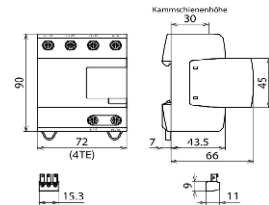

Dimension drawing DV M2 TNS 255 FM

Modular combined lightning current and surge arrester for TN-S systems.

Type Part No.	DV M2 TNS 255 FM 954 405
SPD according to EN 61643-11 / IEC 61643-11	type 1 + type 2 + type 3 / class I + class II + class III
Nominal voltage (a.c.) (U_N)	230 / 400 V (50 / 60 Hz)
Max. continuous operating voltage (a.c.) (U_C)	255 V (50 / 60 Hz)
Lightning impulse current (10/350 μ s) [L1+L2+L3+N-PE] (I_{total})	100 kA
Specific energy [L1+L2+L3+N-PE] (W/R)	2.50 MJ/ohms
Lightning impulse current (10/350 μ s) [L, N-PE] (I_{imp})	25 kA
Specific energy [L,N-PE] (W/R)	156.25 kJ/ohms
Nominal discharge current (8/20 μ s) [L/N-PE]/[L1+L2+L3+N-PE] (I_n)	25 / 100 kA
Voltage protection level [L-PE]/[N-PE] (U_p)	≤ 1.5 / ≤ 1.5 kV
Open-circuit voltage of the combination wave generator (U_{oc})	6 kV
Follow current extinguishing capability (a.c.) (I_f)	50 kA _{rms}
Follow current limitation / Selectivity	No tripping of a 32 A gG fuse up to 50 kA _{rms} (prosp.)
Short-circuit current rating [L-N]/[N-PE] (I_{scCR})	50 kA _{rms}
Response time (t_A)	≤ 100 ns
Max. backup fuse (L) up to $I_K = 50$ kA _{rms}	250 A gG
Temporary overvoltage (TOV) [L-N] (U_T) – Characteristic	440 V / 120 min. – withstand
Let-through energy with an S20K275 ($I_{imp} = 2.5$ to 25 kA)	< 1 J
Operating temperature range [parallel] / [series] (T_U)	-40 °C ... +80 °C / -40 °C ... +60 °C
Operating state / fault indication	green / red
Number of ports	1
Cross-sectional area (L1, L2, L3, N, PE, \perp) (min.)	10 mm ² solid / flexible
Cross-sectional area (L1, L2, L3, N, PE, \perp) (max.)	35 mm ² stranded / 25 mm ² flexible
For mounting on	35 mm DIN rails acc. to EN 60715
Place of installation	indoor installation
Degree of protection	IP 20
Capacity	4 module(s), DIN 43880
Approvals	VDE, KEMA, UL
Type of remote signalling contact	yes / changeover contact
Switching capacity (a.c.)	250 V / 0.5 A
Switching capacity (d.c.)	250 V / 0.1 A; 125 V / 0.2 A; 75 V / 0.5 A
Cross-sectional area for remote signalling terminals	max. 1.5 mm ² solid / flexible
For use in switchgear installations with prospective short-circuit currents of more than 50 kA _{rms} (tested by the German VDE)	-----
– Max. prospective short-circuit current	100 kA _{rms} (220 kA _{peak})
– Limitation / Extinction of mains follow currents	up to 100 kA _{rms} (220 kA _{peak})
– Max. backup fuse (L) up to $I_K = 100$ kA _{rms}	250 A gG

Use for 16.7 Hz traction power supply systems

Type Part No.	DV M2 TNS 255 FM 954 405
– Test voltage AC (U_C)	266 V
– Nominal voltage (a.c.) (U_N)	230 / 400 V
– Nominal frequency (a.c.) (f_N)	16.7 Hz
– Max. backup fuse	160 A gG @ 16,7 Hz
Weight	524 g
Customs tariff number (Comb. Nomenclature EU)	85363090
GTIN	4013364400894
PU	1 pc(s)

DEHNguard

DG M TNS ACI 275 FM (952 440)

- ACI switch / spark gap combination integrated in the protection module
- Prewired complete unit consisting of a base part and plug-in protection modules
- High reliability due to "Thermo Dynamic Control" SPD monitoring device and ACI technology



Figure without obligation

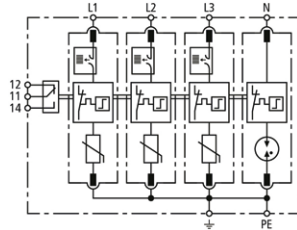

Basic circuit diagram DG M TNS ACI 275 FM

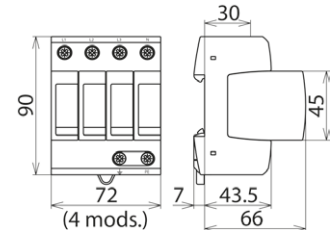

Dimension drawing DG M TNS ACI 275 FM

Modular surge arrester with Advanced Circuit Interruption (ACI) for TN-S systems.

Type	DG M TNS ACI 275 FM
Part No.	952 440
SPD according to EN 61643-11 / IEC 61643-11	type 2 / class II
Energy coordination with terminal equipment (≤ 10 m)	type 2 + type 3
Nominal a.c. voltage (U_N)	230 / 400 V (50 / 60 Hz)
Max. continuous operating voltage AC [L-PE] (U_C)	275 V (50 / 60 Hz)
Max. continuous operating voltage (a.c.) [N-PE] (U_C)	255 V (50 / 60 Hz)
Nominal discharge current (8/20 μ s) (I_n)	20 kA
Voltage protection level [L-PE] / [N-PE] (U_P)	≤ 1.5 / ≤ 1.5 kV
Response time (t_A)	≤ 100 ns
Additional external fuse	not required
Short-circuit withstand capability (I_{SCCR})	25 kA _{rms}
Temporary overvoltage (TOV) (U_T) – Characteristic	440 V / 120 min. – withstand
Operating temperature range (T_U)	-40 °C ... +80 °C
Operating state / fault indication	green / red
Number of ports	1
Cross-sectional area (min.)	1.5 mm ² solid / flexible
Cross-sectional area (max.)	35 mm ² stranded / 25 mm ² flexible
For mounting on	35 mm DIN rails acc. to EN 60715
Enclosure material	thermoplastic, red, UL 94 V-0
Place of installation	indoor installation
Degree of protection	IP 20
Capacity	4 module(s), DIN 43880
Approvals	KEMA
Type of remote signalling contact	changeover contact
Switching capacity (a.c.)	250 V / 0.5 A
Switching capacity (d.c.)	250 V / 0.1 A; 125 V / 0.2 A; 75 V / 0.5 A
Cross-sectional area for remote signalling terminals	max. 1.5 mm ² solid / flexible
Weight	449 g
Customs tariff number (Comb. Nomenclature EU)	85363030
GTIN	4013364376625
PU	1 pc(s)

DEHNcube

DCU YPV SCI 1000 2M (900 920)

- Prewired multipole surge arrester with IP 65 degree of protection for photovoltaic systems
- Combined disconnection and short-circuiting device with safe electrical isolation in each protective path (patented SCI principle)
- Easy and fast implementation of surge protection measures since no space is required in a separate insulating enclosure



Figure without obligation

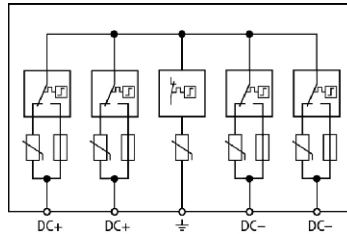

Basic circuit diagram DCU YPV SCI 1000 2M

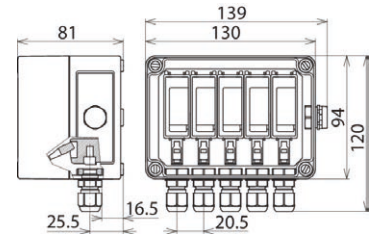

Dimension drawing DCU YPV SCI 1000 2M

Four-pole surge arrester with IP 65 degree of protection and three-step d.c. switching device for PV inverters for protecting two MPP inputs.

Type	DCU YPV SCI 1000 2M
Part No.	900 920
SPD according to EN 61643-31 / IEC 61643-31	type 2 / class II
Max. PV voltage (U_{CPV})	1000 V
Short-circuit current rating (I_{SCPV})	1000 A
Total discharge current (8/20 μ s) (I_{total})	40 kA
Nominal discharge current (8/20 μ s) [(DC+/DC-) --> PE] (I_n)	12.5 kA
Max. discharge current (8/20 μ s) [(DC+/DC-) --> PE] (I_{max})	25 kA
Voltage protection level (U_p)	≤ 4 kV
Voltage protection level at 5 kA (U_p)	≤ 3.5 kV
Response time (t_A)	≤ 25 ns
Operating temperature range (T_U)	-35 °C ... +80 °C
Operating state / fault indication	green / red
Number of ports	1
Cross-sectional area (min.)	2.5 mm ² solid / flexible
Cross-sectional area (max.)	6 mm ² solid / flexible
Place of installation	outdoor
Degree of protection	IP 65
Type	with pressure compensating element
Cover	transparent cover with product label
Colour of enclosure	grey
Number of cable entries	5x \varnothing 3-7 mm
Enclosure dimensions (W x H x D)	130 x 94 x 81 mm
Approvals	KEMA
Weight	617 g
Customs tariff number (Comb. Nomenclature EU)	85363030
GTIN	4013364155053
PU	1 pc(s)

DEHNrail

DR M 2P 255 FM (953 205)

- Two-pole surge arrester consisting of a base part and a plug-in protection module
- High discharge capacity due to heavy-duty zinc oxide varistor / spark gap combination
- Energy coordination with other arresters of the Red/Line product family



Figure without obligation

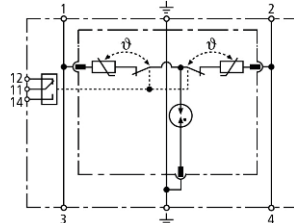

Basic circuit diagram DR M 2P 255 FM

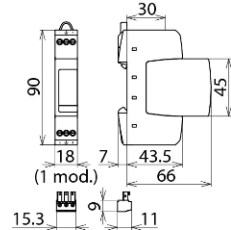

Dimension drawing DR M 2P 255 FM

Two-pole surge arrester consisting of a base part and a plug-in protection module; with floating remote signalling contact.

Type	DR M 2P 255 FM
Part No.	953 205
SPD according to EN 61643-11 / IEC 61643-11	type 3 / class III
Nominal voltage (a.c.) (U_N)	230 V (50 / 60 Hz)
Max. continuous operating voltage (a.c.) (U_C)	255 V (50 / 60 Hz)
Max. continuous operating voltage (d.c.) (U_C)	255 V
Nominal load current (a.c.) (I_L)	25 A
Nominal discharge current (8/20 μ s) (I_n)	3 kA
Total discharge current (8/20 μ s) [L+N-PE] (I_{total})	5 kA
Combination wave (U_{OC})	6 kV
Combination wave [L+N-PE] ($U_{OC total}$)	10 kV
Voltage protection level [L-N] / [L/N-PE] (U_P)	≤ 1250 / ≤ 1500 V
Response time [L-N] (t_A)	≤ 25 ns
Response time [L/N-PE] (t_A)	≤ 100 ns
Max. mains-side overcurrent protection	25 A gG or B 25 A
Short-circuit withstand capability for mains-side overcurrent protection with 25 A gG (I_{SCCR})	6 kA _{rms}
Temporary overvoltage (TOV) [L-N] (U_T) – Characteristic	335 V / 5 sec. – withstand
Temporary overvoltage (TOV) [L-N] (U_T) – Characteristic	440 V / 120 min. – safe failure
Temporary overvoltage (TOV) [L/N-PE] (U_T) – Characteristic	335 V / 120 min. – withstand
Temporary overvoltage (TOV) [L/N-PE] (U_T) – Characteristic	440 V / 5 sec. – withstand
Temporary overvoltage (TOV) [L+N-PE] (U_T) – Characteristic	1200 V + U_{REF} / 200 ms – safe failure
Operating temperature range (T_U)	-40 °C ... +80 °C
Operating state / fault indication	green / red
Number of ports	1
Cross-sectional area (min.)	0.5 mm ² solid / flexible
Cross-sectional area (max.)	4 mm ² solid / 2.5 mm ² flexible
For mounting on	35 mm DIN rails acc. to EN 60715
Enclosure material	thermoplastic, red, UL 94 V-0
Place of installation	indoor installation
Degree of protection	IP 20
Capacity	1 module(s), DIN 43880
Approvals	KEMA, VDE, UL, CSA
Type of remote signalling contact	changeover contact
Switching capacity (a.c.)	250 V / 0.5 A
Switching capacity (d.c.)	250 V / 0.1 A; 125 V / 0.2 A; 75 V / 0.5 A
Cross-sectional area for remote signalling terminals	max. 1.5 mm ² solid / flexible
Weight	84 g
Customs tariff number (Comb. Nomenclature EU)	85363030
GTIN	4013364108318
PU	1 pc(s)

BLITZDUCTORconnect

BCO ML2 BE 24 (927 224)

- LifeCheck arrester monitoring and integrated status indication
- Modular two-pole arrester for optimal protection of two single lines
- For installation in conformity with the lightning protection zone concept at the boundaries from $0_A -2$ and higher



Figure without obligation

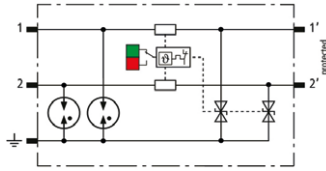

Basic circuit drawing BCO ML2 BE 24

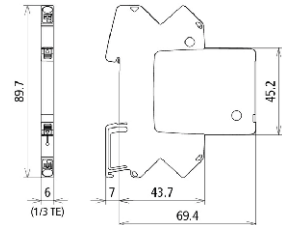

Dimension drawing BCO ML2 BE 24

Space-saving, modular combined arrester with a width of 6 mm and push-in connection technology with status indication for protecting two single lines sharing a common reference potential as well as unbalanced interfaces. With signal disconnection for maintenance purposes.

Type	BCO ML2 BE 24
Part No.	927 224
SPD class	TYPE 1 P1
Impulse category	D1, C1, C2, C3, B2
Nominal voltage (U_N)	24 V
Max. continuous operating voltage (d.c.) (U_C)	33 V
Max. continuous operating voltage (a.c.) (U_C)	23.3 V
Nominal current at 70 °C (I_L)	0.75 A
D1 Total lightning impulse current (10/350 μ s) (I_{imp})	3 kA
D1 Lightning impulse current (10/350 μ s) per line (I_{imp})	1.5 kA
C2 Total nominal discharge current (8/20 μ s) (I_n)	10 kA
C2 Nominal discharge current (8/20 μ s) per line (I_n)	5 kA
Voltage protection level line-line for I_n C2 (U_p)	≤ 90 V
Voltage protection level line-PG for I_n C2 (U_p)	≤ 75 V
Voltage protection level line-line for I_n C1 (U_p)	≤ 90 V
Voltage protection level line-PG for I_n C1 (U_p)	≤ 75 V
Voltage protection level line-line at 1 kV/ μ s C3 (U_p)	≤ 85 V
Voltage protection level line-PG at 1 kV/ μ s C3 (U_p)	≤ 45 V
Series resistance per line	1 ohm(s)
Cut-off frequency line-line (f_c)	3.4 MHz
Operating temperature range (T_U)	-40 °C ... +80 °C
Operating state / fault indication	green / red
Degree of protection	IP 20
Connection (input / output)	push-in / push-in
Cross-sectional area (solid)	0.2-2.5 mm ²
Cross-sectional area (flexible)	0.2-2.5 mm ²
Earthing via	35 mm DIN rails acc. to EN 60715
Enclosure material	polyamide PA 6.6
Colour	yellow
Test standards	IEC 61643-21 / EN 61643-21
Approvals	UL, CSA, EAC, ATEX, IECEx, CCC, SIL
ATEX approvals	TÜV 20 ATEX 8527 X: II 3G Ex ec IIC T4 Gc
IECEx approvals	IECEx TUR 20.0063X: Ex ec IIC T4 Gc
China Compulsory Certification	CCC no. 2021312304001192
Extended technical data:	-----
- Max. discharge current (8/20 μ s) [1/2 - PG], [1+2 - PG] (I_{max})	20 kA
- Discharge current (8/20 μ s) [1/2 - PG], [1+2 - PG]	10 kA (10x)
- Voltage protection level line-PG at 1 kV/ μ s C3 after being subjected to I_{max} (U_p)	≤ 45 V
Weight	34 g
Customs tariff number (Comb. Nomenclature EU)	85363010
GTIN	4013364405608
PU	1 pc(s)

BLITZDUCTORconnect

BCO ML2 BD 24 (927 244)

- LifeCheck arrester monitoring and integrated status indication
- Modular two-pole arrester for optimal protection of one pair
- For installation in conformity with the lightning protection zone concept at the boundaries from $0_A - 2$ and higher



Figure without obligation

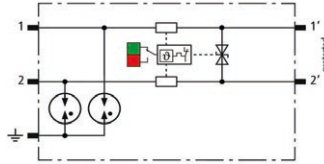

Basic circuit diagram BCO ML2 BD 24

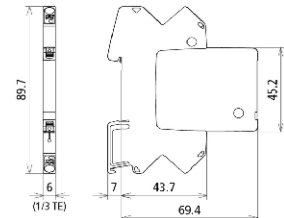

Dimension drawing BCO ML2 BD 24

Space-saving, modular combined arrester with a width of 6 mm and push-in connection technology with status indication for protecting one pair of unearthed balanced interfaces. With signal disconnection for maintenance purposes.

Type Part No.	BCO ML2 BD 24 927 244
SPD class	TYPE 1P2
Impulse category	D1, C1, C2, C3, B2
Nominal voltage (U_N)	24 V
Max. continuous operating voltage (d.c.) (U_C)	36 V
Max. continuous operating voltage (a.c.) (U_C)	25.4 V
Nominal current at 70 °C (I_N)	0.75 A
D1 Total lightning impulse current (10/350 μ s) (I_{imp})	3 kA
D1 Lightning impulse current (10/350 μ s) per line (I_{imp})	1.5 kA
C2 Total nominal discharge current (8/20 μ s) (I_n)	10 kA
C2 Nominal discharge current (8/20 μ s) per line (I_n)	5 kA
Voltage protection level line-line for I_n C2 (U_p)	≤ 57 V
Voltage protection level line-PG for I_n C2 (U_p)	≤ 600 V
Voltage protection level line-line for I_n C1 (U_p)	≤ 57 V
Voltage protection level line-PG for I_n C1 (U_p)	≤ 600 V
Voltage protection level line-line at 1 kV/ μ s C3 (U_p)	≤ 46 V
Voltage protection level line-PG at 1 kV/ μ s C3 (U_p)	≤ 600 V
Series resistance per line	1 ohm(s)
Cut-off frequency line-line (f_c)	5.8 MHz
Operating temperature range (T_U)	-40 °C ... +80 °C
Operating state / fault indication	green / red
Degree of protection	IP 20
Connection (input / output)	push-in / push-in
Cross-sectional area (solid)	0.2-2.5 mm ²
Cross-sectional area (flexible)	0.2-2.5 mm ²
Earthing via	35 mm DIN rails acc. to EN 60715
Enclosure material	polyamide PA 6.6
Colour	yellow
Test standards	IEC 61643-21 / EN 61643-21
Approvals	UL, CSA, EAC, ATEX, IECEx, CCC, SIL
ATEX approvals	TÜV 20 ATEX 8527 X: II 3G Ex ec IIC T4 Gc
IECEx approvals	IECEx TUR 20.0063X: Ex ec IIC T4 Gc
China Compulsory Certification	CCC no. 2021312304001192
Extended technical data:	-----
- Max. discharge current (8/20 μ s) [1/2 - PG], [1+2 - PG] (I_{max})	20 kA
- Discharge current (8/20 μ s) [1/2 - PG], [1+2 - PG]	10 kA (10x)
- Voltage protection level line-PG at 1 kV/ μ s C3 after being subjected to I_{max} (U_p)	≤ 600 V
Weight	34 g
Customs tariff number (Comb. Nomenclature EU)	85363010
GTIN	4013364405639
PU	1 pc(s)

BLITZDUCTORconnect

BCO ML2 BD HF 5 (927 271)

- LifeCheck arrester monitoring and integrated status indication
- Modular two-pole arrester for optimal protection of one pair of high-frequency signal circuits
- For installation in conformity with the lightning protection zone concept at the boundaries from $0_A - 2$ and higher



Figure without obligation

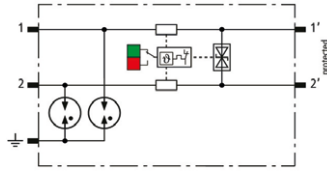

Basic circuit diagram BCO ML2 BD HF 5

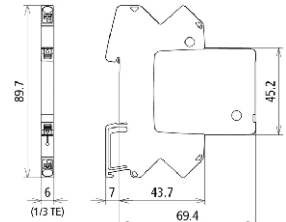

Dimension drawing BCO ML2 BD HF 5

Space-saving, modular combined arrester with a width of 6 mm and push-in connection technology with status indication for protecting one pair of unearthed high-frequency bus systems as well as balanced interfaces. With signal disconnection for maintenance purposes.

Type	BCO ML2 BD HF 5
Part No.	927 271
SPD class	TYPE 1P2
Impulse category	D1, C1, C2, C3, B2
Nominal voltage (U_N)	5 V
Max. continuous operating voltage (d.c.) (U_c)	8.5 V
Max. continuous operating voltage (a.c.) (U_c)	6.0 V
Nominal current at 70 °C (I_L)	0.75 A
D1 Total lightning impulse current (10/350 μ s) (I_{imp})	3 kA
D1 Lightning impulse current (10/350 μ s) per line (I_{imp})	1.5 kA
C2 Total nominal discharge current (8/20 μ s) (I_n)	10 kA
C2 Nominal discharge current (8/20 μ s) per line (I_n)	5 kA
Voltage protection level line-line for I_n C2 (U_p)	≤ 42 V
Voltage protection level line-PG for I_n C2 (U_p)	≤ 600 V
Voltage protection level line-line for I_n C1 (U_p)	≤ 42 V
Voltage protection level line-PG for I_n C1 (U_p)	≤ 600 V
Voltage protection level line-line at 1 kV/ μ s C3 (U_p)	≤ 15 V
Voltage protection level line-PG at 1 kV/ μ s C3 (U_p)	≤ 600 V
Series resistance per line	1 ohm(s)
Cut-off frequency line-line (f_c)	100 MHz
Operating temperature range (T_u)	-40 °C ... +80 °C
Operating state / fault indication	green / red
Degree of protection	IP 20
Connection (input / output)	push-in / push-in
Cross-sectional area (solid)	0.2-2.5 mm ²
Cross-sectional area (flexible)	0.2-2.5 mm ²
Earthing via	35 mm DIN rails acc. to EN 60715
Enclosure material	polyamide PA 6.6
Colour	yellow
Test standards	IEC 61643-21 / EN 61643-21
Approvals	UL, CSA, EAC, ATEX, IECEx, CCC, SIL
ATEX approvals	TÜV 20 ATEX 8527 X: II 3G Ex ec IIC T4 Gc
IECEx approvals	IECEx TUR 20.0063X: Ex ec IIC T4 Gc
China Compulsory Certification	CCC no. 2021312304001192
Extended technical data:	-----
- Max. discharge current (8/20 μ s) [1/2 - PG], [1+2 - PG] (I_{max})	20 kA
- Discharge current (8/20 μ s) [1/2 - PG], [1+2 - PG]	10 kA (10x)
- Voltage protection level line-PG at 1 kV/ μ s C3 after being subjected to I_{max} (U_p)	≤ 600 V
Weight	34 g
Customs tariff number (Comb. Nomenclature EU)	85363010
GTIN	4013364405660
PU	1 pc(s)

DEHNpatch

DPA CLE IP66 (929 221)

- Indoor / outdoor applications (IP 66)
- GBit Ethernet applications and structured cabling systems according to class E up to 250 MHz
- Power over Ethernet IEEE 802.3 (up to PoE++ / 4PPoE)
- For installation in conformity with the lightning protection zone concept at the boundaries from $0_B -2$ and higher



Figure without obligation

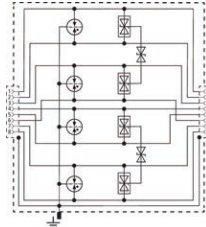

Basic circuit diagram DPA CLE IP66

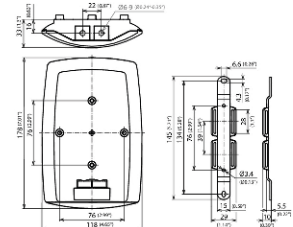

Dimension drawing DPA CLE IP66

Universal surge arrester for GBit Ethernet applications, Power over Ethernet (IEEE 802.3 compliant up to PoE++ / 4PPoE) and similar applications in structured cabling systems up to class E in indoor and outdoor areas in an IP66 rated enclosure impervious to dust and water. Protection of all pairs with gas discharge tubes and one adapted filter matrix for each pair. Fully shielded surge protective solution with RJ 45 sockets. Universal mounting bracket for pole and wall mounting.

External accessories: Tensioning straps for pole mounting

Type	DPA CLE IP66
Part No.	929 221
SPD class	TYPE 2 P₁
Nominal voltage (U_N)	5 V
Max. continuous operating voltage d.c. line-line (U_C)	8.5 V
Max. continuous operating voltage (a.c.) (U_C)	6 V
Max. continuous operating voltage (d.c.) pair-pair (PoE) (U_C)	60 V
Nominal current (I_N)	1 A
D1 Lightning impulse current (10/350 μ s) per line (I_{imp})	0.8 kA
D1 Total lightning impulse current (10/350 μ s) (I_{imp})	4 kA
C2 Nominal discharge current (8/20 μ s) line-line (I_n)	400 A
C2 Nominal discharge current (8/20 μ s) line-PG (I_n)	2.5 kA
C2 Total nominal discharge current (8/20 μ s) (I_n)	10 kA
Voltage protection level line-line for I_n C2 (U_p)	≤ 170 V
Voltage protection level line-PG for I_n C2 (U_p)	≤ 600 V
Voltage protection level line-line for I_n C2 (PoE) (U_p)	≤ 120 V
Voltage protection level line-line at 1 kV/ μ s C3 (U_p)	≤ 180 V
Voltage protection level line-PG at 1 kV/ μ s C3 (U_p)	≤ 500 V
Voltage protection level pair-pair at 1 kV/ μ s C3 (PoE) (U_p)	≤ 120 V
Cut-off frequency (f_c)	250 MHz
Operating temperature range (T_U)	-40 °C ... +80 °C
Degree of protection (with installed cables)	IP 66
For mounting on	pole / wall
Connection (input / output)	RJ45 socket / RJ45 socket
Pinning	1/2, 3/6, 4/5, 7/8
Earthing via	enclosure with pole / wall bracket
Enclosure material	aluminium die-cast, nickel plated
Colour	bare surface
Test standards	IEC 61643-21 / EN 61643-21
Approvals	UL, CSA, EAC
External accessories	tensioning straps for pole mounting
Weight	606 g
Customs tariff number (Comb. Nomenclature EU)	85363010
GTIN	4013364342866
PU	1 pc(s)

Surge Protection
Lightning Protection
Safety Equipment
DEHN protects.

DEHN SE
Hans-Dehn-Str. 1
Postfach 1640
92306 Neumarkt, Germany

Tel. +49 9181 906-0
Fax +49 9181 906-1100
info@dehn.de
www.dehn-international.com



www.dehn-international.com/partners

Type designations of products mentioned in this white paper which are at the same time registered trademarks are not especially marked. Hence the absence of TM or [®] markings does not indicate that the type designation is a free trade name. Nor can it be seen whether patents or utility models and other intellectual and industrial property rights exist. We reserve the right to introduce changes in performance, configuration and technology, dimensions, weights and materials in the course of technical progress. The figures are shown without obligation. Misprints, errors and modifications excepted. Reproduction in any form whatsoever is forbidden without our authorisation.